

S7 Custom Linear LED Surface

Datasheet



Product codes

Product name:	Length:	Family:	Circuit Wattage:	Colour temp:	Beam angle:	Body:	Driver:
S7	2.5m xx	LN	7W/m	3K 4K	DF180	White (W)	ND Phase Dali 010V

Photometrics

CCT: 3000K
Total Circuit Efficacy: 103lm/W
Source lumens output (7W/m): 720lm/m

CCT: 4000K
Total Circuit Efficacy: 105lm/W
Source lumens output (7W/m): 735lm/m

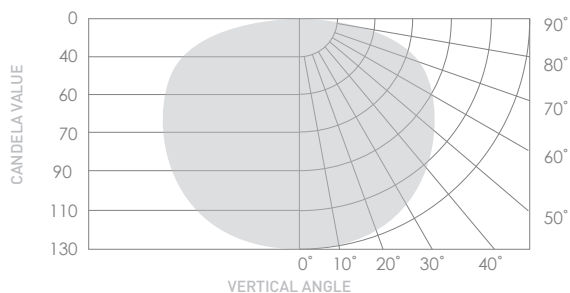

Beam angle: DF180°

Dimensions (mm)

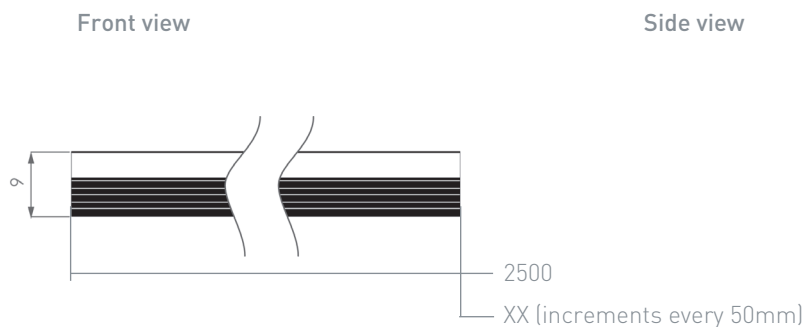

Electrical

Length	2.5m	xx
Power Usage	1802lm/ 1837lm	W* (103lm / 105lm)
7W/m	17.5W	W=7W*xx

Dimmable: Yes
Power Usage: 7W/m
IP rating: IP44
Surge protection: 3100V
Driver power factor: >0.9
Driver Input voltage: 220-265V

LED input voltage: 24V
DC cable length: 630mm

Operational

Operating temp.: -30 to 85°C
Ambient temp.: -28 to 55°C
Lifetime: L70 B10 = 50,000hrs
L50 = 80,000hrs
Warranty: 7 years of luminaire warranty
& 5 years of driver warranty

Compatibility

Dimming:
Non-Dimmable (ND)
Digital Driver (PHASE) *<https://brightgreen.com/digital-driver>
DALI (DALI)
0-10V (010)

Installation

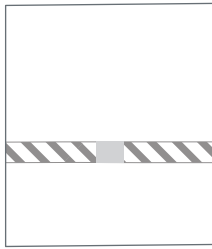

Step 1

Pre-cut the recess with desired length, then drill a 5mm hole cut out to thread the cable through.

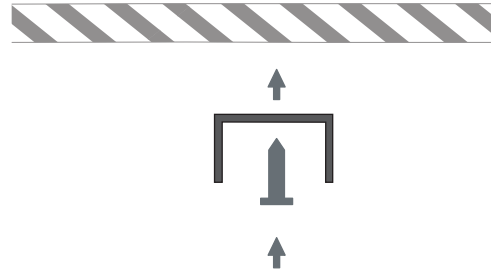

Step 2

Attach the provided mounting clips to the top of the cavity with the provided screws

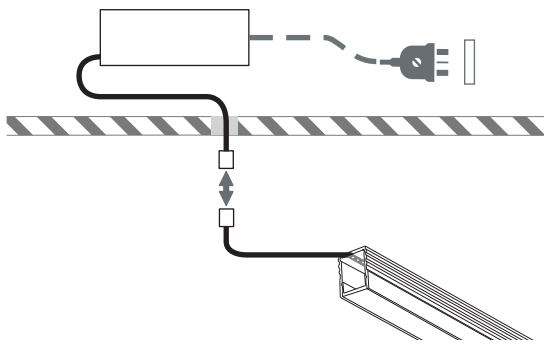

Step 3

Remote mount and connect the driver to the mains power cable in line with Australian standards. Wire the low voltage luminaire cable to the driver and then the cable through the hole cutouts.

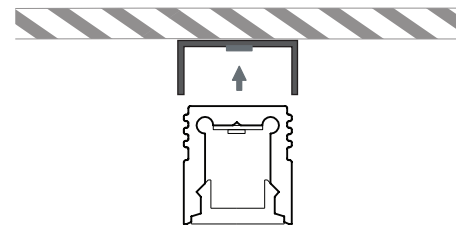

Step 4

Snap the product into the mounting clips.

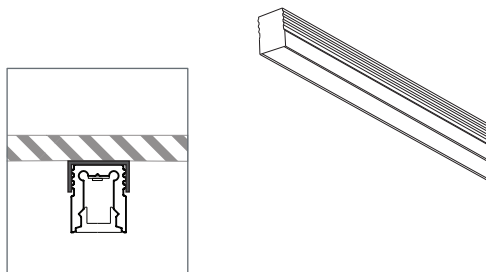

Step 5

Installation complete.