

NST10.IP LED strip light

Datasheet



Product codes

Unit: NST10.IP.1.0m NST10.IP.5.0m	Series: LN	Colour temp. (K): 3K 4K RGB [Optional]	Beam angle (°): DF180	Colour: W (White)
--	----------------------	--	---------------------------------	-----------------------------

Optional Alumium Extrusion:
COM-NST10.IP-PRO-2.0m-1.0
(Not yet applicable for RGB)

Photometrics

CCT: 3000K
Efficacy: 98 lm/W
Lumen output: 1000 lm

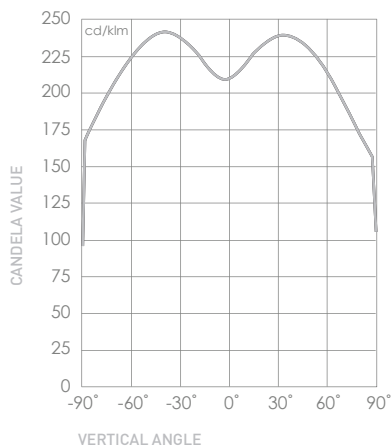

CCT: 4000K
Efficacy: 108 lm/W
Lumen output: 1090 lm

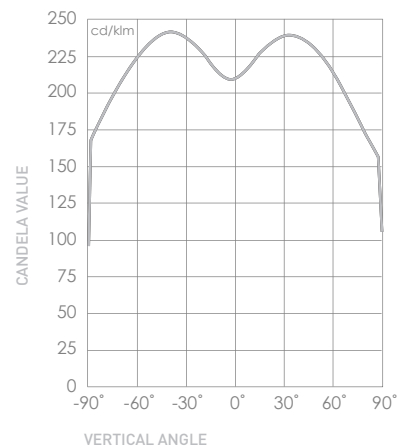

Dimensions (mm)

End view LED Strip

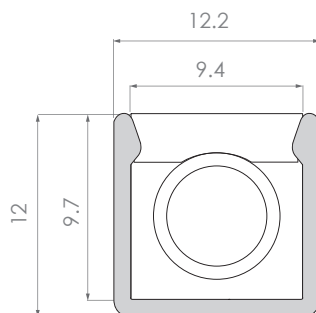

Side view LED Strip



Accessories

COM-NST10.IP-ENDCAP with Cable-1.0

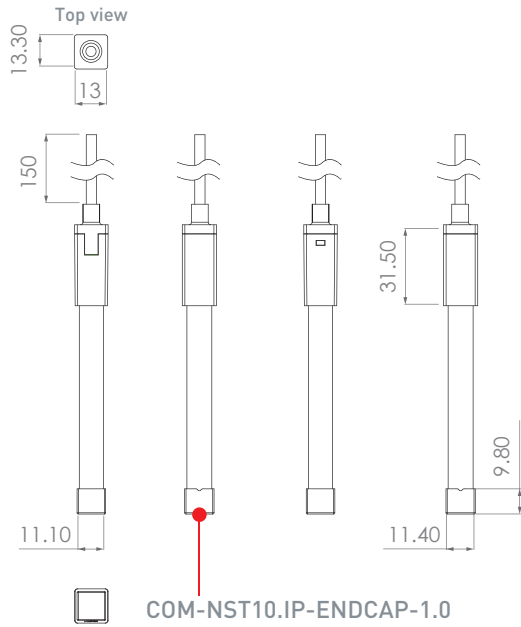

COM-NST10.IP-JUMPER CONNECTOR-1.0

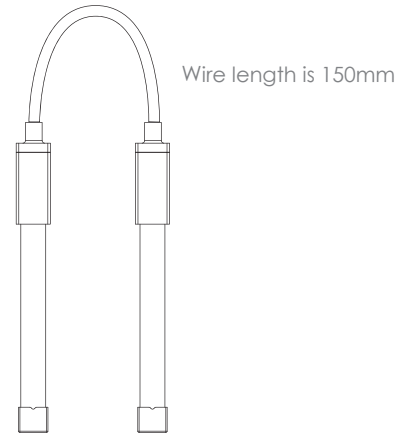

COM-NST10.IP-SPLICE CONNECTOR-1.0

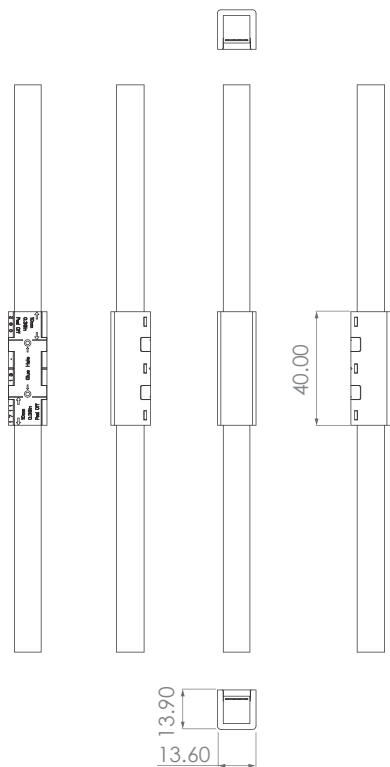

MATERIALS

- PC
 
- Stainless steel
 
- PVC
 

Electrical

Power Usage	Length	1m	5m
	CCT		
10W/m	3K	1000lm	5000lm
10W/m	4K	1090lm	5450m

LED input voltage:
24V

Power usage:
10

IP rating:
IP67

Operational

Operating temp.:
-20 to 50°C

Average temp.:
60°C

Lifetime:
50,000hrs

Warranty:
7 years of luminaire warranty
& 5 years of driver warranty

Compatibility

Drivers:
Non-Dimmable (ND)
Digital Driver (PHASE)
DALI (DALI)
0-10V (010)
SMART
CASAMBI

Driver input voltage:
100-265V

Surge protection:
3100V

Driver power factor:
>0.9

Note: For RGB, RGBW and Dayshift CCTs, Non-dimmable and Phase drivers are not applicable

Installation - Mounting Clips

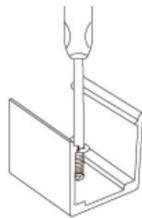

Step 1

Attach the provided mounting clips to the top of the cavity with the provided screws.

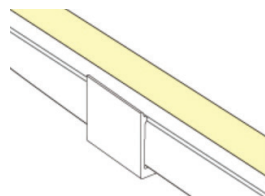

Step 2

Fasten the luminaire to the wall using the provided screws.



Step 3

Wire the strip into the driver (sold separately) using the terminal block. Plug the driver into a mounted general power outlet (GPO) in the ceiling.

Installation - Aluminum Profile

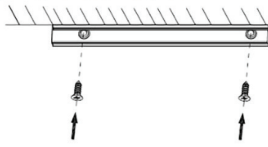

Step 1

Attach the aluminum profiles to the wall with the provided screws.

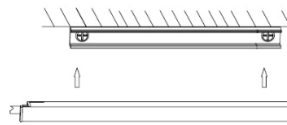

Step 2

Clip the luminaire into the aluminum profile.

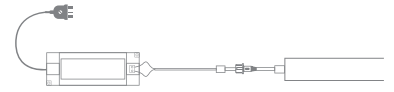

Step 3

Wire the strip into the driver (sold separately) using the terminal block. Plug the driver into a mounted general power outlet (GPO) in the ceiling.

Optional

Fold the strip, the minimum bending diameter is 120mm.

Accessories included:

- 1m set = (1 plain endcap and 1 endcap with cable attached to the strip lights) + 1 spare plain endcap
- 1m set = Mounting clips: 1 Bag = 3 clips + 3 screws
- 5m set = (1 plain endcap and 1 endcap with cable attached to the strip lights) + 5 spare plain endcap
- 5m set = Mounting clips: 1 Bag = 15 clips + 15 screws

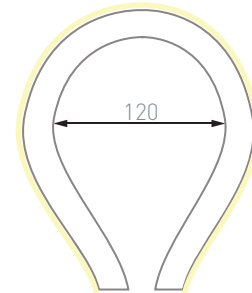

Additional Installation - Plain end cap

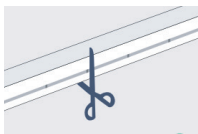

Step 1

Cut the appropriate place.

Note: Actual length of the light is 34mm shorter to account for the 2 endcaps

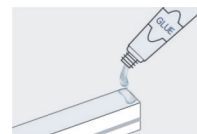

Step 2

Apply glue to the section uniformly after cutting.

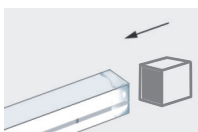

Step 3

Insert the section into the plug according to direction of arrow

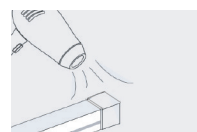

Step 4

Dry the join with a heat gun or hair dryer until the plug and the section are firm.

Additional Installation - End cap with cables

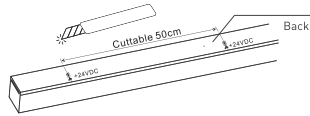

Step 1

Cut the white backing and the plastic sheet. Do not cut the copper layer. Cuttable length is 50 cm.
Caution: Turn off the power before cutting.

Note: Actual length of the light is 34mm shorter to account for the 2 endcaps

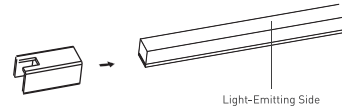

Step 2

Insert the strip light into the transparent plastic accessory.

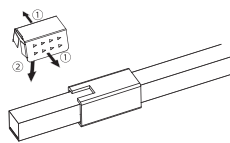

Step 3

Force apart both caps of the hardware by hands. Clip the hardware into the strip light.

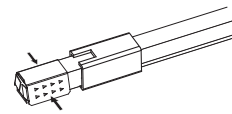

Step 4

The head of the hardware should be clipped tightly into the strip light. Compress the caps after fitting it into the strip light.

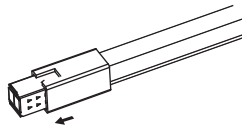

Step 5

Push the transparent plastic accessory back to the hardware.

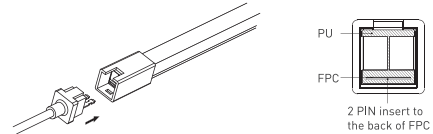

Step 6

Install the plug



Step 7

Identify the positive and negative pole.

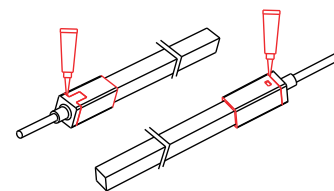

Step 8

The cable can be made from IP20 to IP67 by applying sealant glue to the connection.

Apply glue onto the parts marked red. To achieve better results, glue should be applied twice.

Attention: The glue should be reapplied 5 minutes later when the first glue becomes dry)

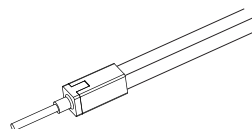

Step 9

Finished

Additional Installation - Jumper connection

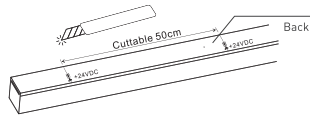

Step 1

Cut the white backing and the plastic sheet. Do not cut the copper layer. Cuttable length is 50 cm. Caution: Turn off the power before cutting.

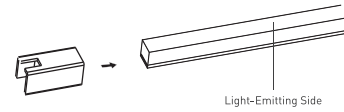

Step 2

Insert the strip light into the transparent plastic accessory.

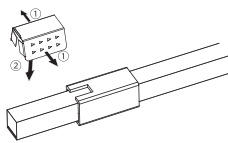

Step 3

Force apart both caps of the hardware by hands. Clip the hardware into the strip light.

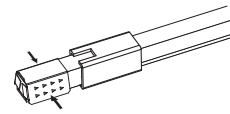

Step 4

The head of the hardware should be clipped tightly into the strip light. Compress the caps after fitting it into the strip light.

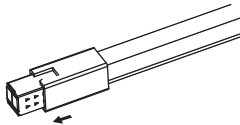

Step 5

Push the transparent plastic accessory back to the hardware.

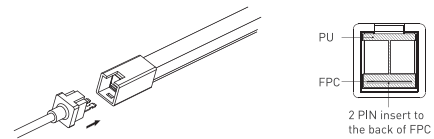

Step 6

Install the plug



Step 7

Identify the positive and negative pole.

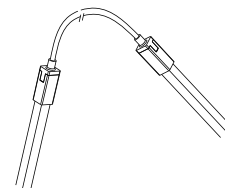

Step 8

Finished

Additional Installation - Splice connection

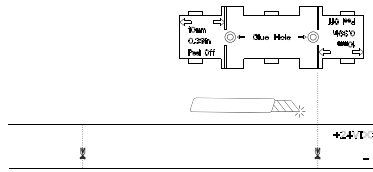

Step 1

Find the suitable cut position, and mark it out. Cut off the opal PU tube from the back side.

Attention: Do not cut off the copper foil. All the operations are based on non-emitting area (the bottom side).

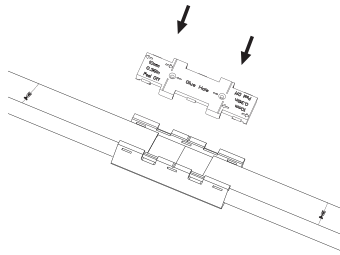

Step 3

Lock part A with part B tightly.

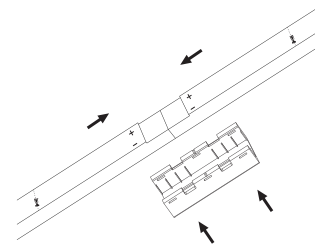

Step 2

Connect the cut strips together. Please connect the positive and negative electrode correspondingly. Press strips into the splice connectors.

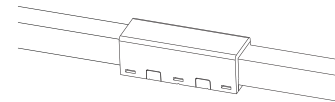

Step 4

Installation finished, please connect power supply.